

OUTER FRAME

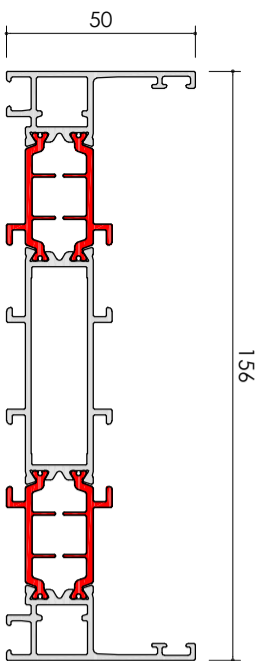

LEAF / INTERLOCK

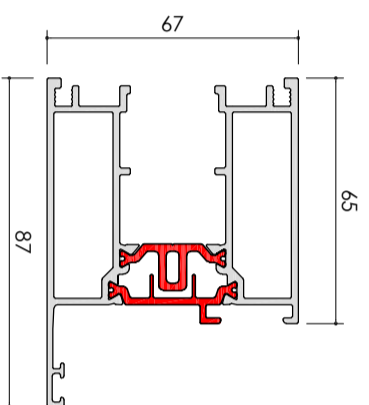

LOCK STILE

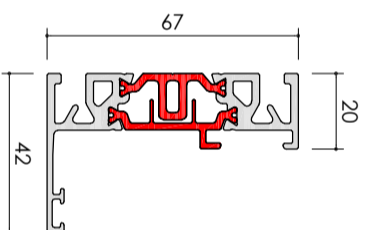

HP ADD ON

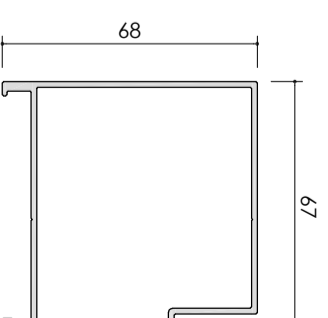

K2400

K2404

K2413

K2416

K2406

K2418

INTERLOCK CHICANE

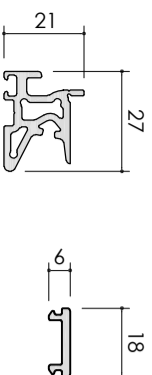

800155

800167

THRESHOLD

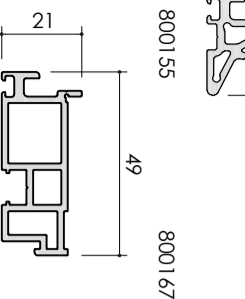

800166

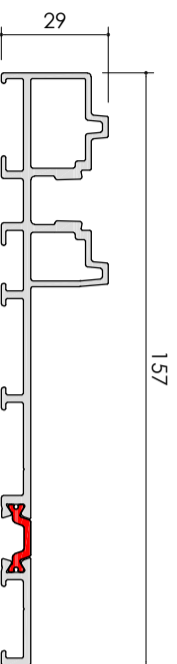

K2410

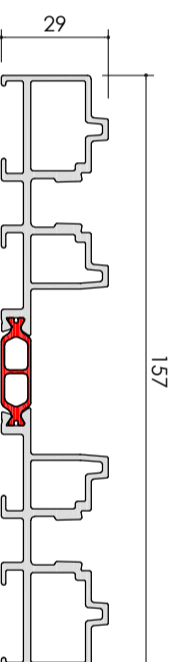

K2411

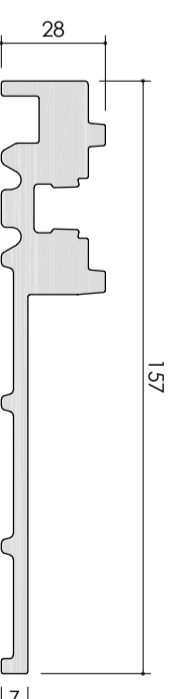

800150

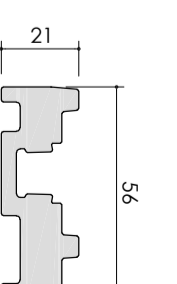

800151

THRESHOLD TRIM

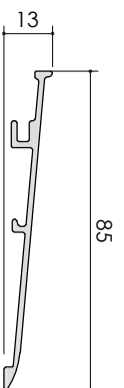

K2415

TRACK

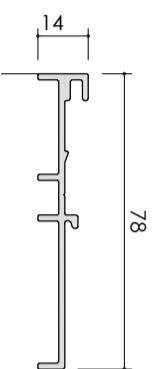

800156

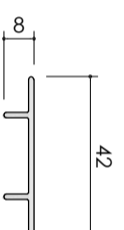

K2421

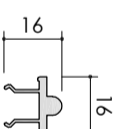

K2107

HEAD INSERT

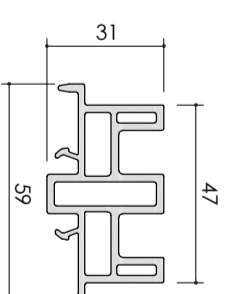

800152

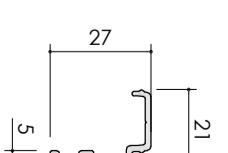

K2417

PLATES

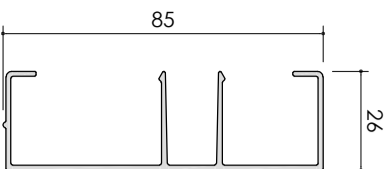

K2414

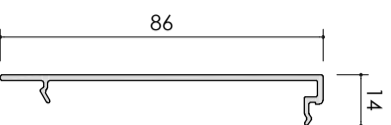

K2405

REINFORCEMENT

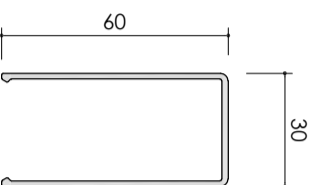

K1460

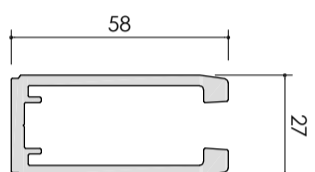

K1459

GLAZING BEAD

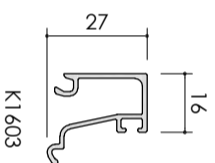

K1603

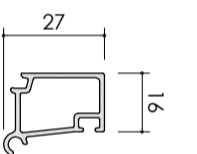

K1613

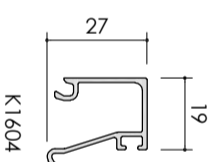

K1604

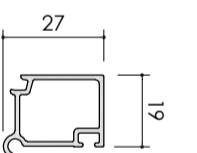

K1614

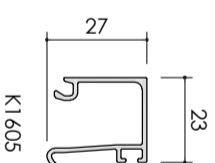

K1605

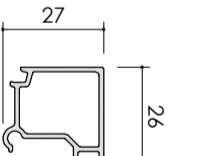

K1616

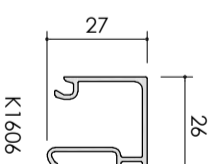

K1606



www.aluk.co.uk

SCI156

DATE : 01.10.2021

ISSUE : AWCSC15600

SCALE : 1:1 @ A1

PAGE : 1 of 1